

وزارة التربية الوطنية

السنة الدراسية 2014/2015

متوسطة شريف محمد - الوادي -

المدة: ساعة ونصف الاختبار الأخير في مادة العلوم الفيزيائية و التكنولوجيا المستوى: 4 متوسط

(12):

(06):

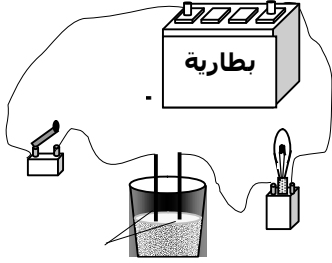

- I

(1

0.5

(2

**

01

()

-II



(1

0.5

(2

02

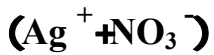

()

-III

(1

0.5

(2

1.5

(06):

. 60Cm

(1

02

(2

/

01

/

02

10^0

M

(3

**

01

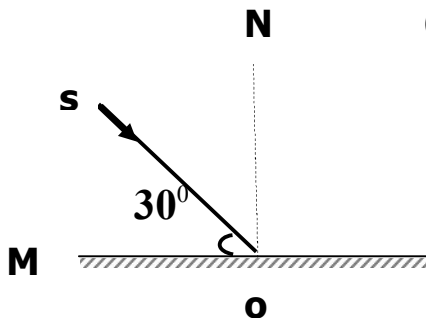

(08):

: _____

- (1
- (2
- (3
- (4

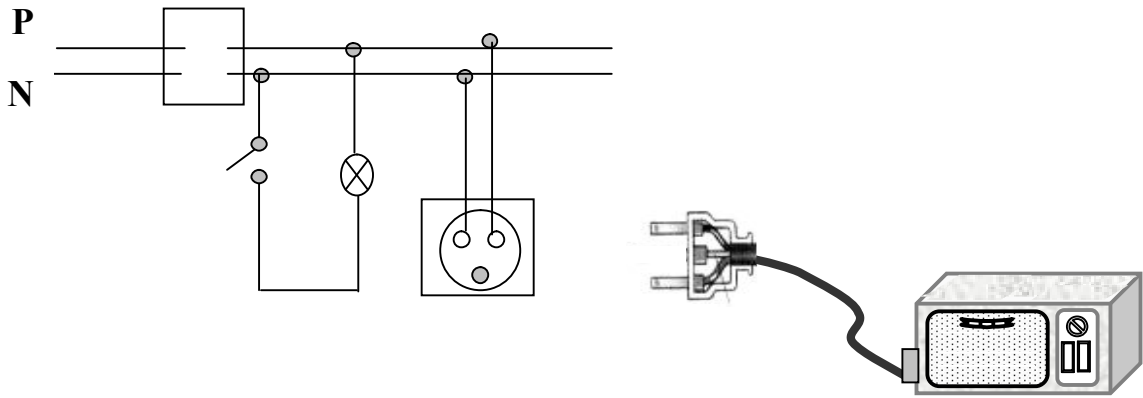

(12):

(06):

-I

0.5 : (1

. : (2

0.5

-II

0.5 (Pb²⁺+2Cl⁻) : (1

: (2

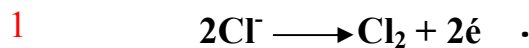
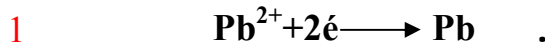

-III

0.5 Cl⁻ : (1

. : (2

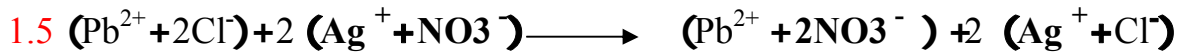

(06):

01 120Cm (1

01 :

(2

01 $\hat{i} = 60^0$ /

01 $\hat{r} = 60^0$ /

01 = :

(3

**

0.5 ن $\beta = 2 \alpha$ علما أن
 $\beta = 10 \times 2$ ومنه

0.5..... $\beta = 20^0$

(08):

: _____
: (1
-(2

()

: -(3

()

-(4

